

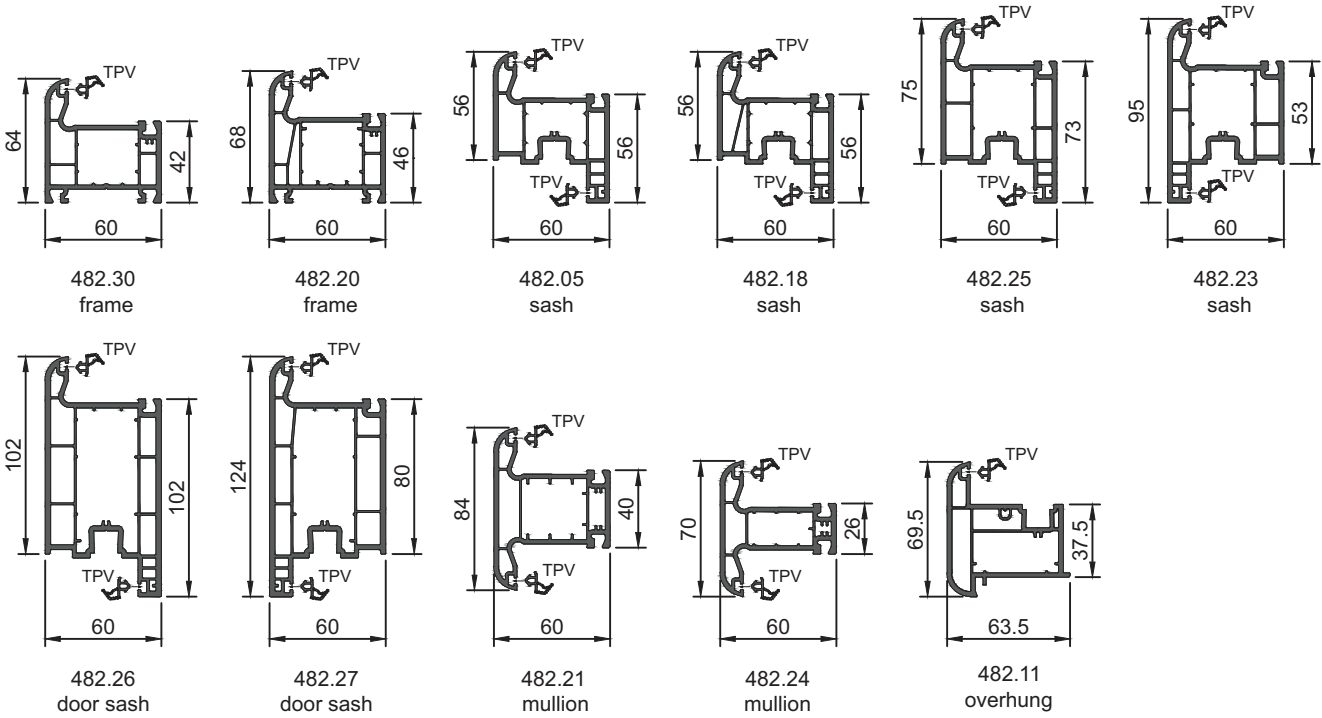

PVC PROFILES SYSTEMS



Main profiles



Glass beads

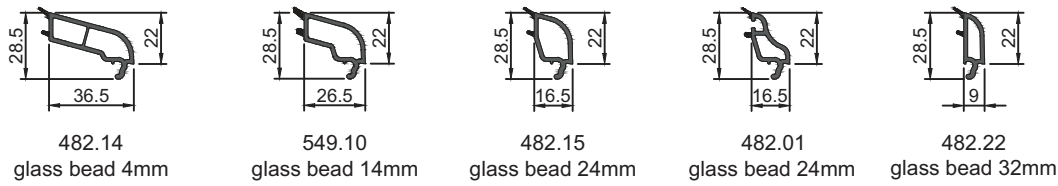

Additional profiles

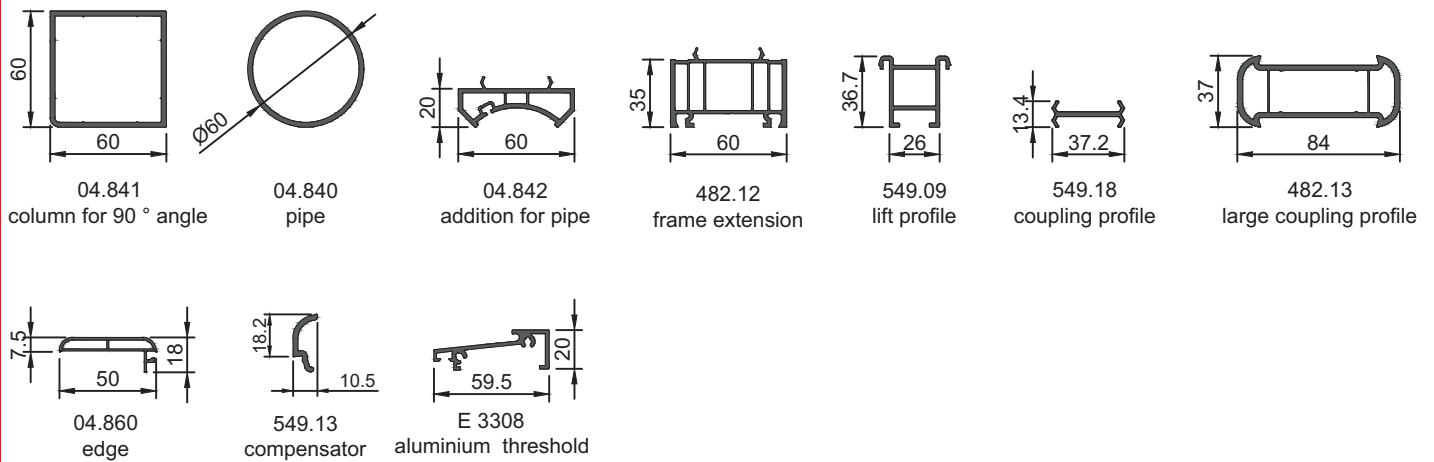

EPDM gaskets



PVC panels and sills

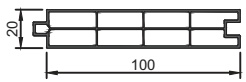

04.844
PVC panel

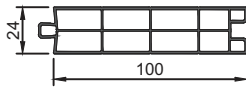

04.843
PVC panel

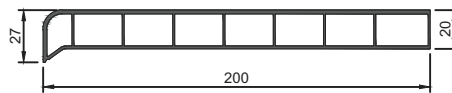

04.846
sill

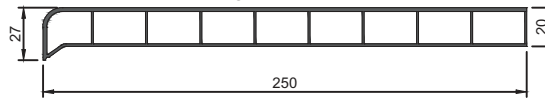

04.847
sill

Reinforcements

For:
482.05
482.18
482.20
482.30

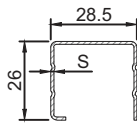

TRE 01
S=1.0mm

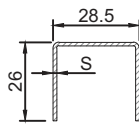

TRE 01
S=0.8mm
S=1.2mm
S=1.5mm
S=2.0mm

For:
482.21

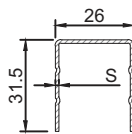

TRE 02-60
S=1.2mm
S=1.5mm
S=2.0mm

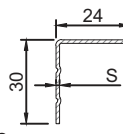

TRE 02
S=1.0mm
S=1.2mm
S=1.5mm
S=2.0mm

For:
482.26
482.27

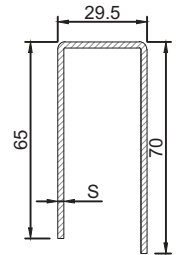

TRE 03
S=2.0mm

For:
04.841

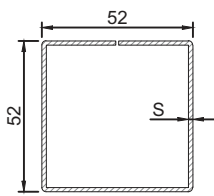

TRE 06
S=1.5mm

For:
482.24

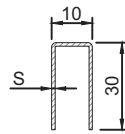

TRE 08
S=1.2mm

For:
04.840

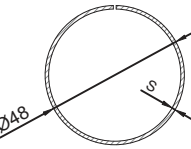

TRE 10
S=1.2mm

For:
482.13

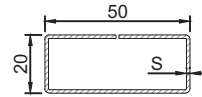

TRE 12
S=1.2mm

For:
482.20
482.30

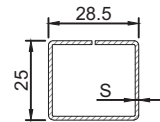

TRE 13
S=1.2mm

For:
482.21

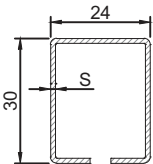

TRE 14
S=1.2mm

For:
482.23
482.25

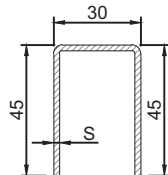

TRE 16
S=1.5mm
S=2.0mm

For:
482.11

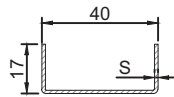

TRE 17
S=1.2mm

For:
482.21

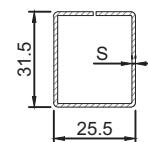

TRE 19
S=1.2mm

Accessories

KM242

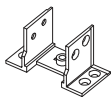

mullion connector for 482.21

KM241



mullion connector for 482.24

KM344

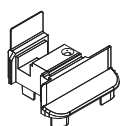

end cover cap for overhung 482.11

KM530

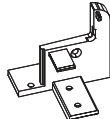

end cap for threshold 60mm

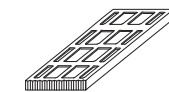

AP3220; AP3230; AP3240; AP3250; glazing spacer

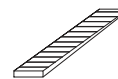

AP3320; AP3324; AP3326; AP3330; AP3332; bridge

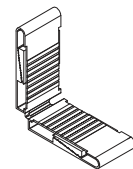

AP3170; AP3174; AP3172; angle

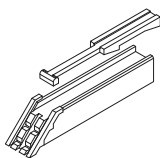

AP3175 angle joint for sash 482.23 and 482.25

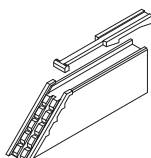

AP3174 angle joint for door sash 482.26 and 482.27

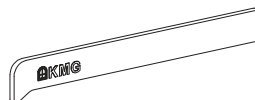

cover cap for sill 04.846- 200mm

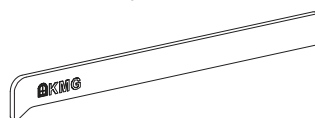

cover cap for sill 04.847- 250mm



Address:
8000 Burgas
South Industrial Zone, Bulgaria

Tel: +359 56 880 440
Fax: +359 56 880 443
office@altest-kmg.com

www.altest-kmg.com